

Entreprise G.F. **INC.**

Quincaillerie Fer martelé Pour meubles et Résidence

Germain Fortier
1776, Route 161
St-Valère
Québec
G0P 1M0
Tel : 819-353-2570
Fax: 819-353-2576

Quincaillerie Fer martelé pour meubles Et Résidences

Page	Reppert	Descriptions
3	1-1	LUMINAIRE - GIROUETTES LOQUET ET VERROU
4	2-1	LOQUETS POUCIERS
5	3-1	LOQUETS POUCIERS
6	3-2	LOQUETS POUCIERS
7	4-1	ENTRÉE DE CLEF - SERRURES - CROCHETS - ŒILLETS - CLEFS
8	5-1	POIGNÉES À ANNEAU - POIGNÉES AVEC BOUTON - BOUTONS
9	6-1	VERROUS POUR FENÊTRE
10	6-2	VERROUS (SEUL) - GAGE OU AGRAFE - PAUMELLE
11	7-1	VERROUS (SEUL) AVEC AGRAFE (SEULEMENT)
12	8-1	VERROUS (SEUL) AVEC GAGE OU AGRAFE
13	9-1	VERROU (SEUL) AVEC AGRAFE (SEULEMENT)
14	10-1	GONDS- LAME - QUEUE DE RAT- FICHE À LARDER Petit Model
15	11-1	GONDS- LAME - QUEUE DE RAT--FICHE À LARDER Gros Model
16	11-2	PAUMELLES POUR PORTE (Pour porte entrée a vif)
17	12-1 13-1	CHARNIÈRES - GOND & GOND DE SURFACE
18	13-2	CHARNIÈRES - GOND & GOND DE SURFACE
19	14-1	GOND AVEC CHARNIÈRES PAUMELLE & QUEUE DE RAT DE SURFACE
20	15-1	CHARNIÈRES A PLAT & ÉQUERRES DÉCORATIFS
21	16-1	CHARNIÈRES DE COFFRES - POIGNÉES - SERRURES DE COFFRES
22	17-1	CHARNIÈRES - GONDS & GONDS DE SURFACE
23	19-1	POIGNÉES À TIRER - FERME VOLET

LUMINAIRE - GIROUETTES
LOQUET ET VERROU

1- 1

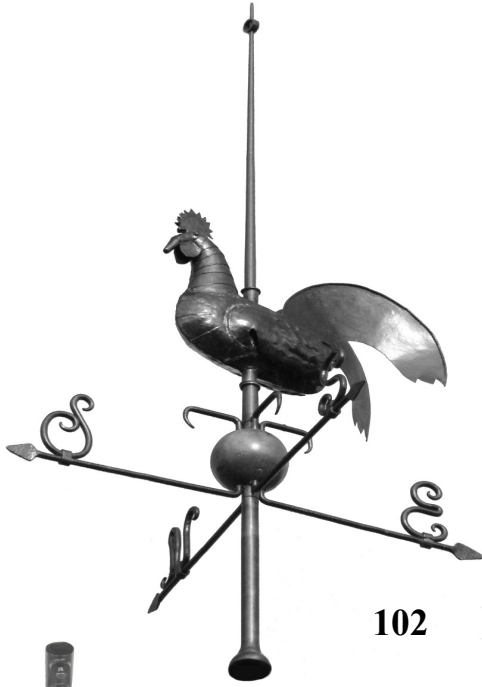

102



Support de girouette



103



104

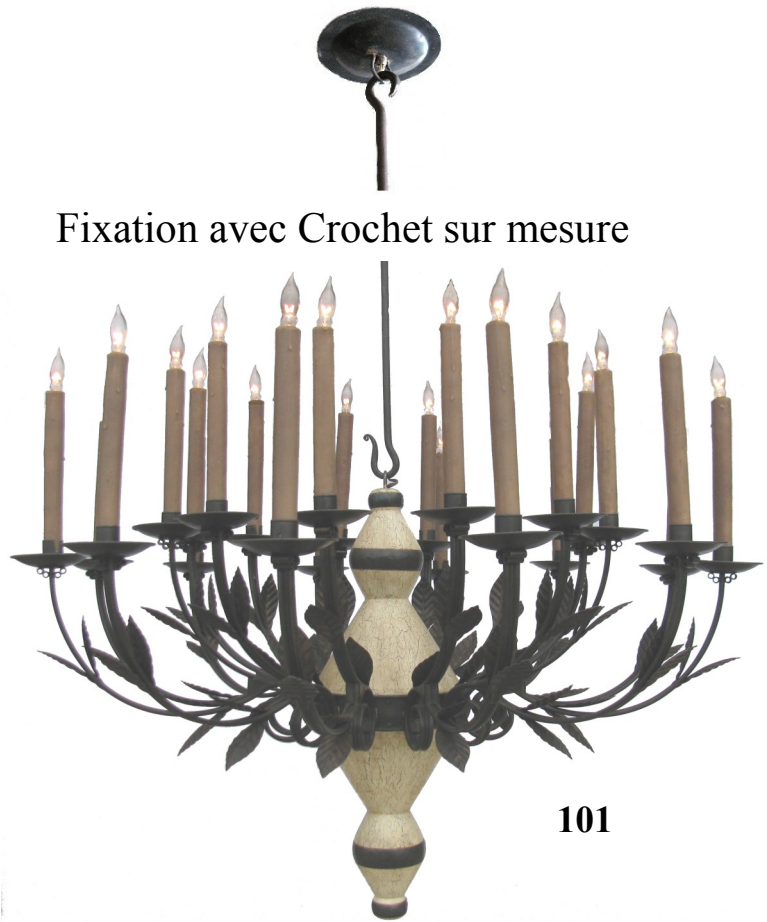

Fixation avec Crochet sur mesure

101

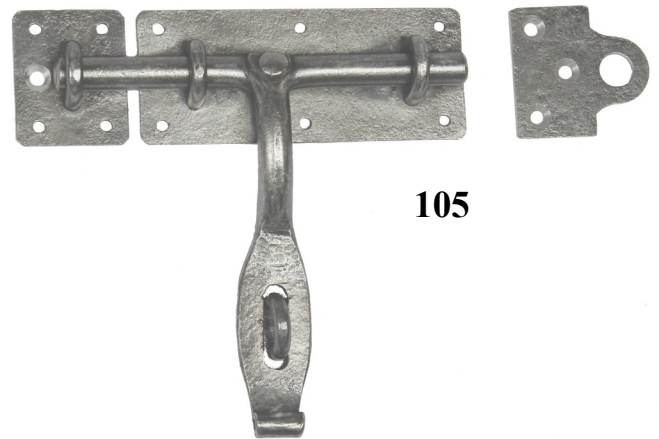

105

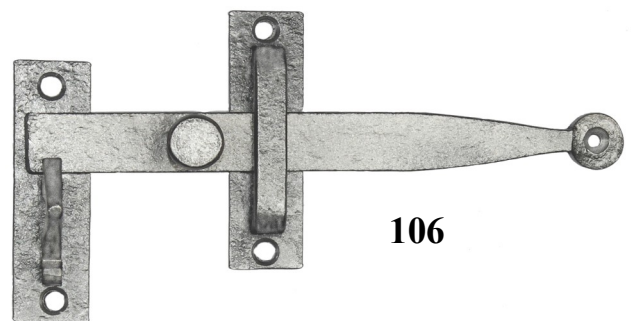

106

2 - 1

LOQUETS POUCIERS

Disponible naturel ou noir oxydé



Avec pêne série A

16mm X 195mm
5/8" X 7-3/4"



202 A -

203 A -

201 A -

207 A -



57mm X 228
2-1/4" X 9"

57mm X 273
2-1/4" X 10-3/4"

51mm X 253
2" X 10"

27mm X 285
2-1/4" X 11-1/4"

201 B -

202 B -

203 B -

207 B -

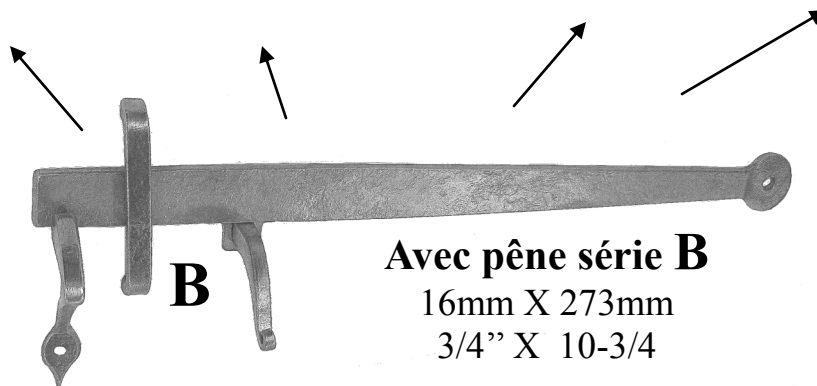

Avec pêne série B

16mm X 273mm
3/4" X 10-3/4"



Piece incluse

Plan d'installation page 46

3 - 1

LOQUETS POUCIERS

Disponible naturel ou noir oxydé

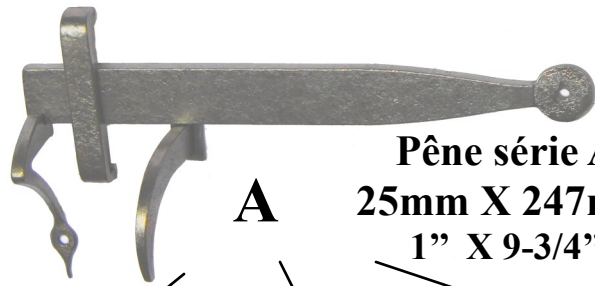

Pêne série A
25mm X 247mm
1" X 9-3/4"

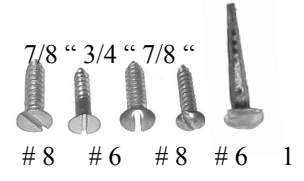

7/8" 3/4" 7/8" 1
#8 #6 #8 #6 1

301 A -



Plate
61mm X 260
2-3/8" X 10-1/4"

302 A -



Plate
70mm X 260
2-3/4" X 10-1/4"

303 A -

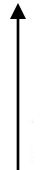

Plate
38mm X 280
1-1/2" X 11"

301 B -



302 B -



303 B -



Piece incluse

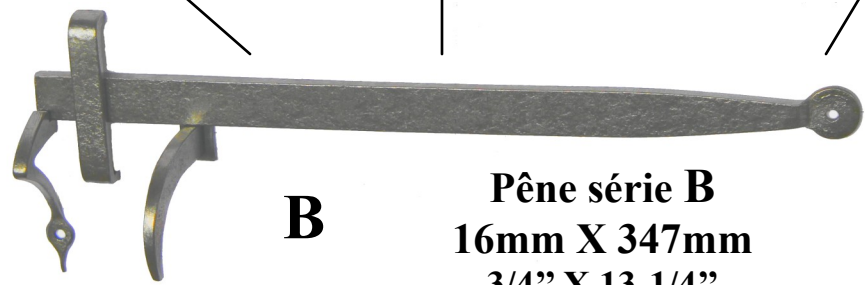

B

Pêne série B
16mm X 347mm
3/4" X 13-1/4"

3 - 2

LOQUETS POUCIERS

Disponibles naturel ou noir oxydé

Pêne

23mm X 411mm

7/8" X 16-3/4"

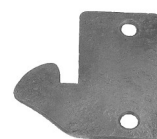
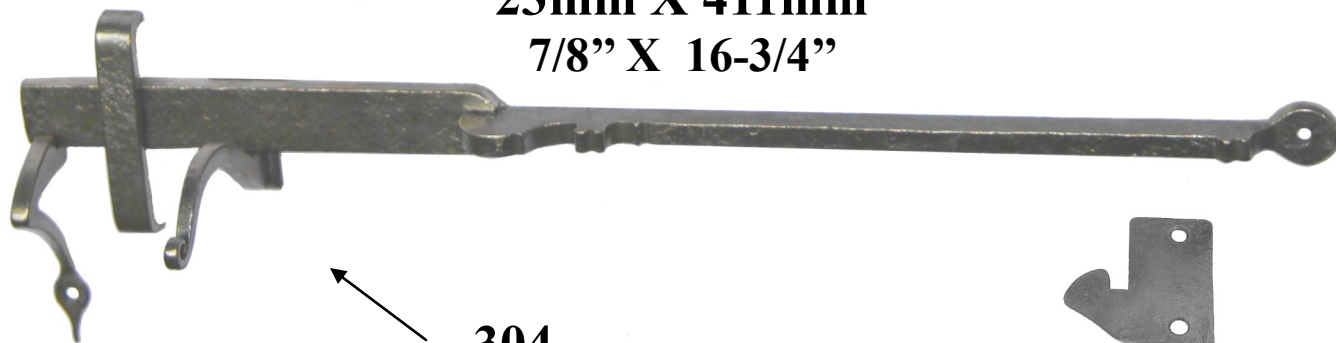

304-

Pièce incluse



Numéro Série	Épaisseur des Portes
304-1	1-1/2"
304-2	1-3/4"
304-3	2"
304-4	2-1/4"
304-5	2-1/2"
304-6	2-3/4"



Plate
76mm X 297
3" X 11-3/4"



ENTRÉES DE CLEFS - SERRURES - CROCHETS ŒILLETS - CLEFS

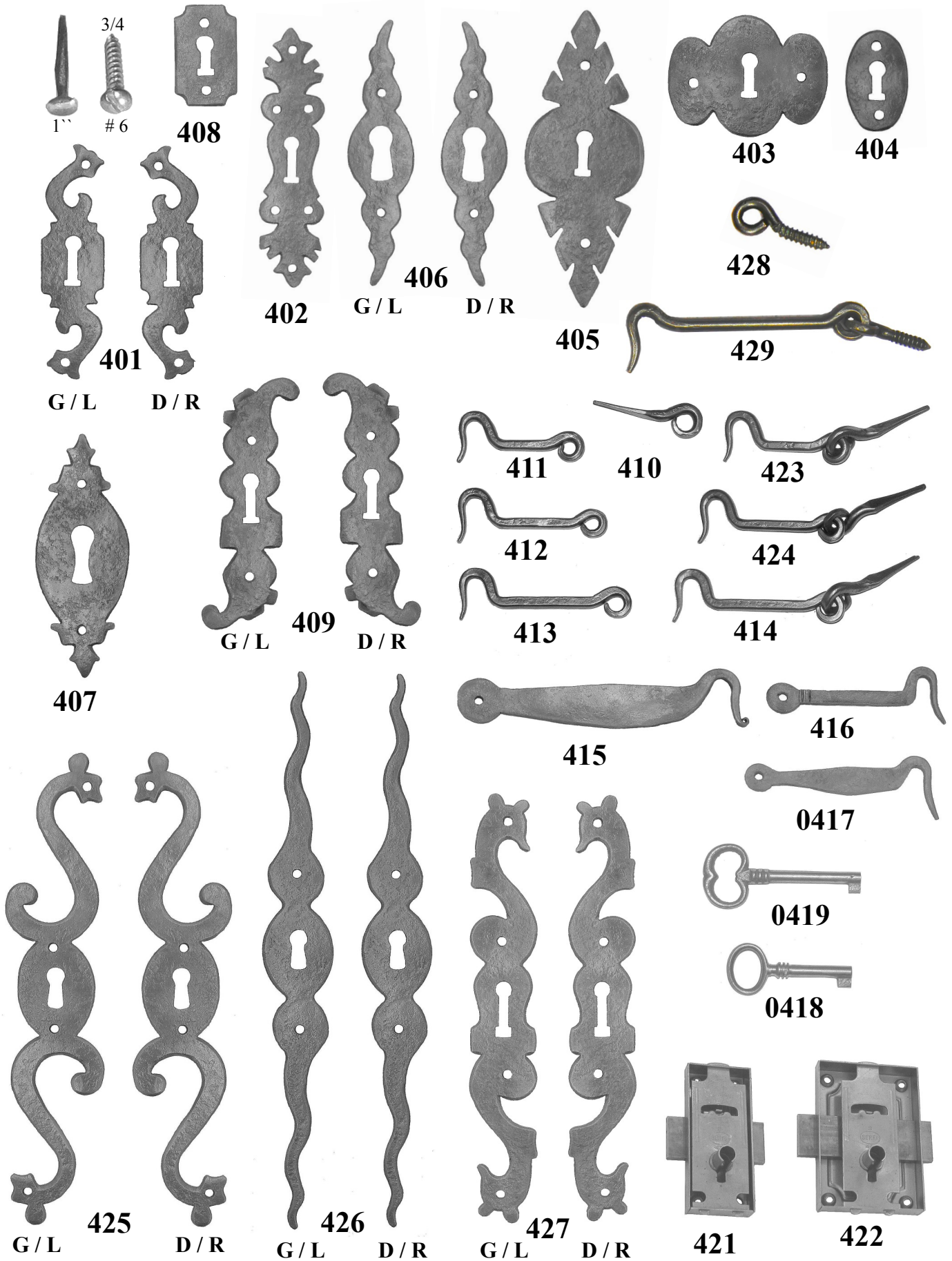

POIGNÉES À ANNEAU - POIGNÉES AVEC BOUTON - BOUTONS

Disponibles naturel ou noir oxydé

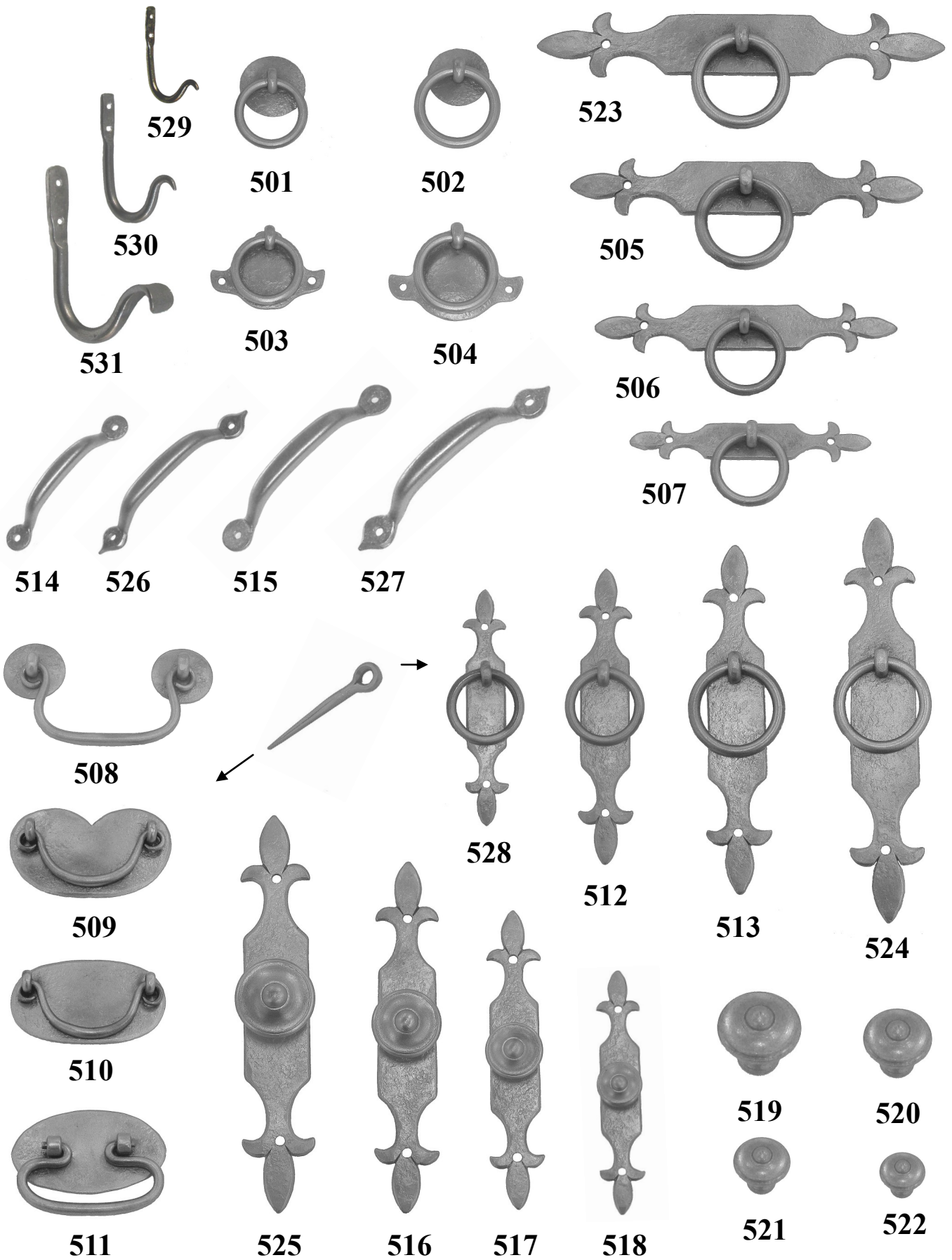

VERROUS POUR FENÊTRES

Disponibles naturel ou noir oxydé

Disp. Sans bouton

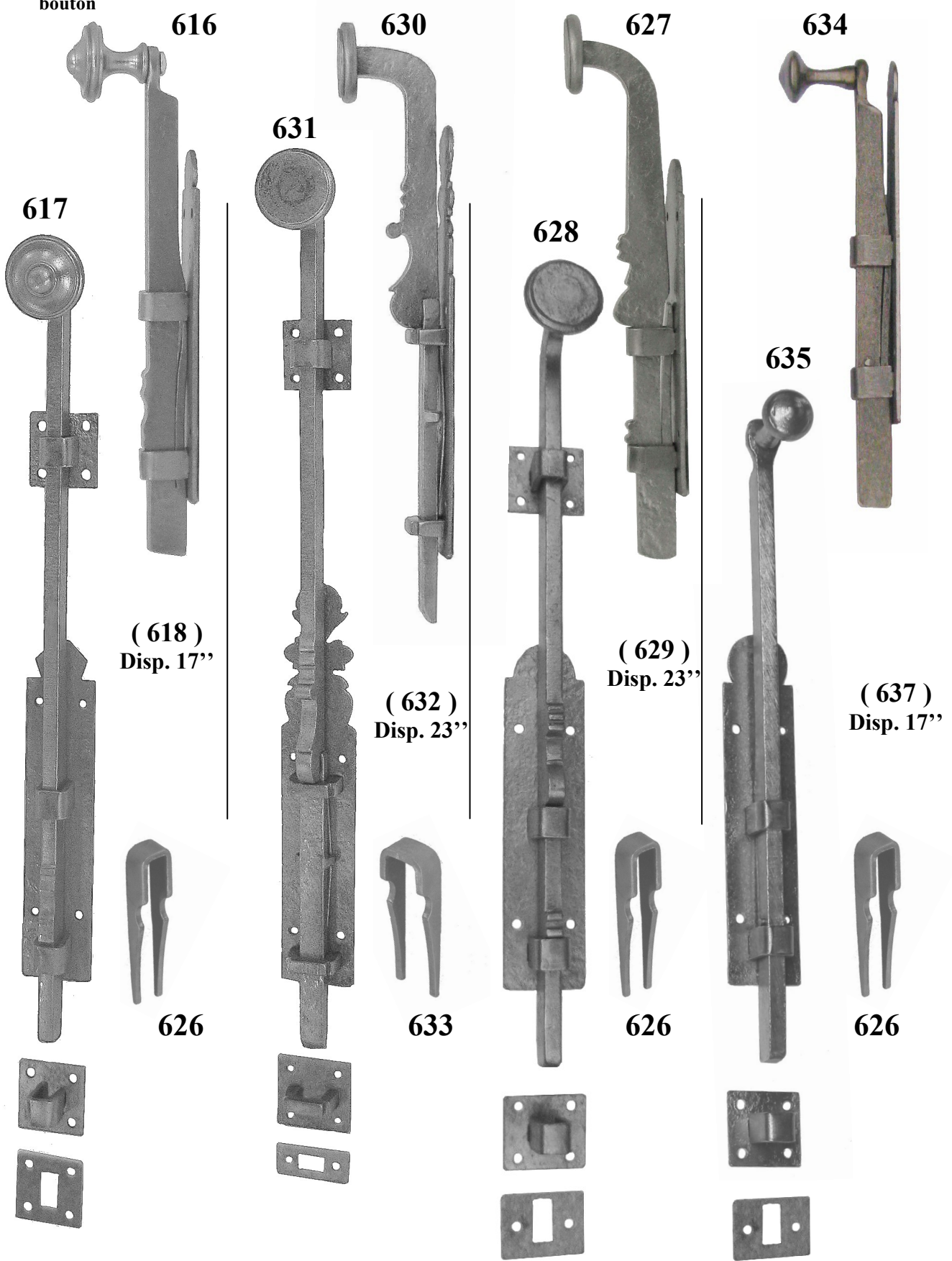

VERROUS (SEUL) - GAGES OU AGRAFES - PAUMELLES

6 - 2

Disponibles naturel ou noir oxydé



616



Gage pour cadre de porte



619



620



601

Pour porte à vif



603

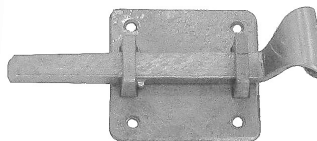

604



605

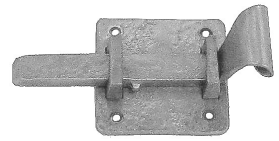

606



602

Pour porte chantournée



607

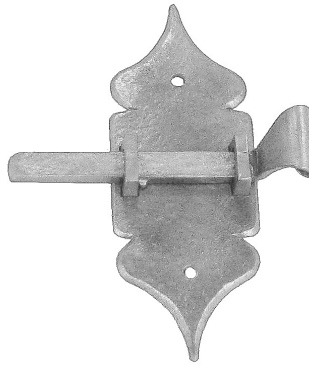

608



609



610

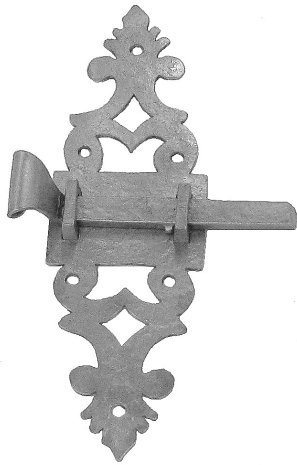

611



616



614

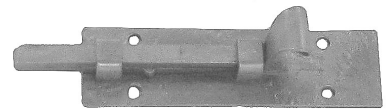

615



612

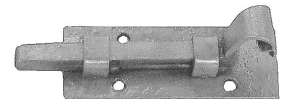

613

IMPORTANT

Installation martoisée
Droite s'installe a gauche
Gauche s'installe a droite

D / R
G / L

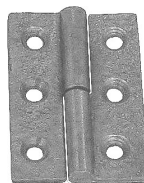

622

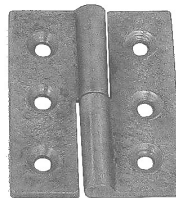

623

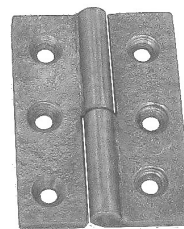

624

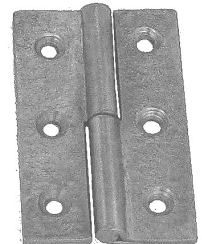

625

VERROUS (SEUL) AVEC AGRAFES (SEULEMENT)

Disponibles naturel ou noir oxydé

7 - 1



Gage pour cadre
de porte



713



0701

Pour porte à vif



702

Pour porte chantournée



703

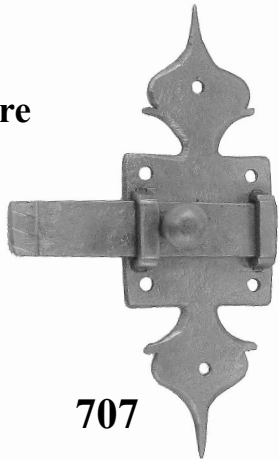

707

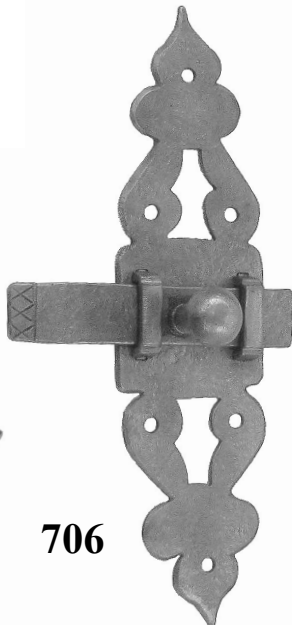

706

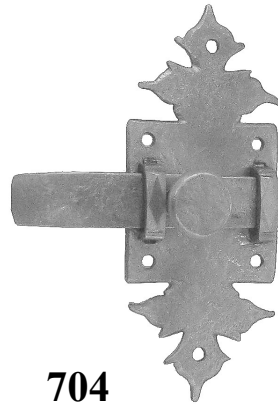

704

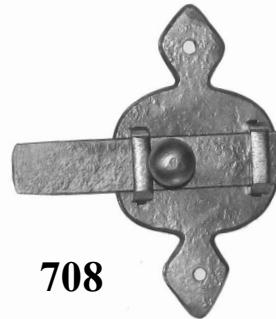

708

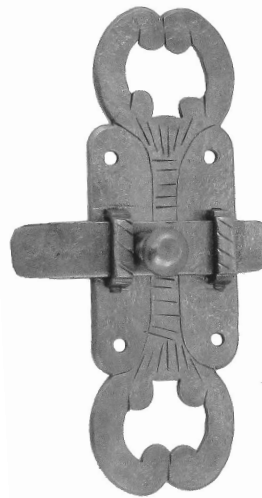

711



705

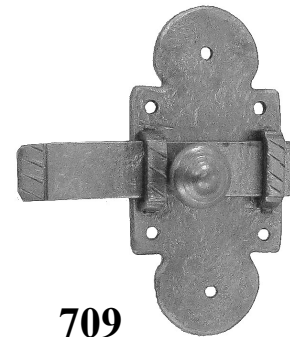

709

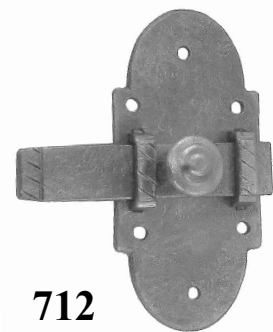

712

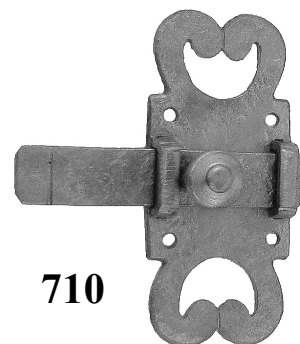

710

VERROUS (SEUL) AVEC GAGES OU AGRAFES

Disponibles naturel ou noir oxydé



818



Gage pour cadre de porte



801

Pour porte à vif



816

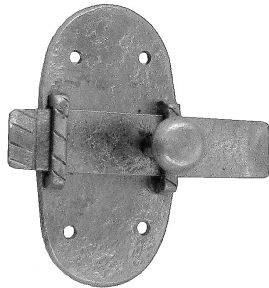

811

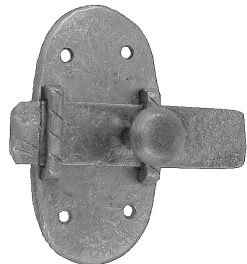

812



803



802

Pour porte chantournée



817



810

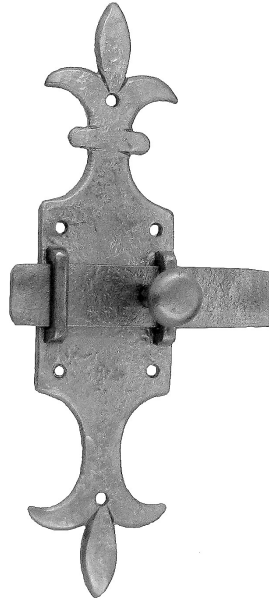

804



805

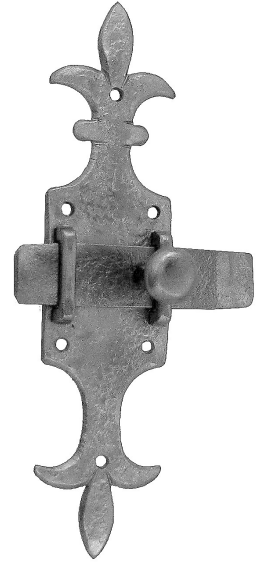

806



808



807

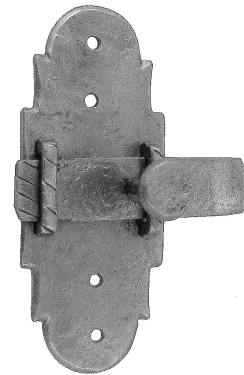

809

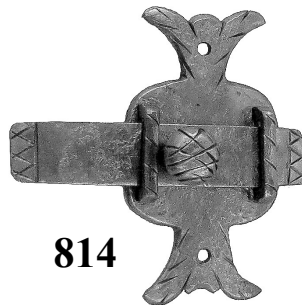

814



813



815

VERROUS (SEUL) AVEC AGRAFES (SEULEMENT)

Disponibles naturel ou noir oxydé



Gage pour cadre de porte



910



802

Pour porte chantournée



817



801

Pour porte à vif



816

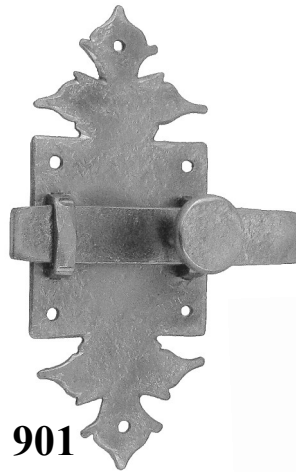

901



902

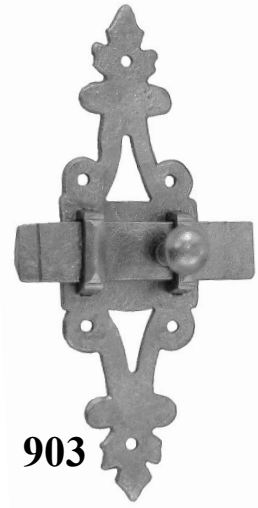

903



907

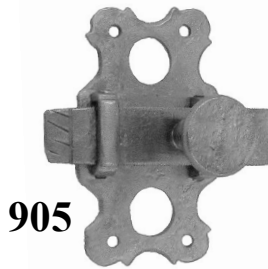

905

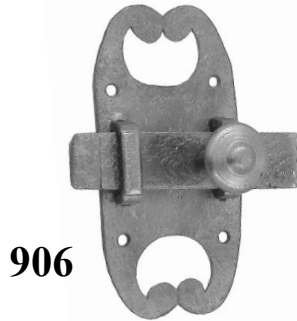

906

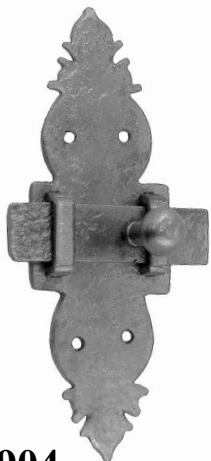

904



908

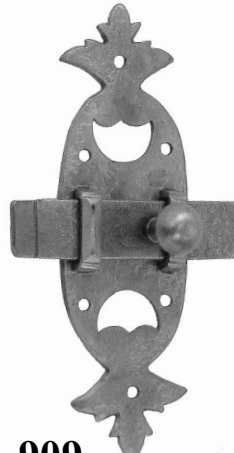

909

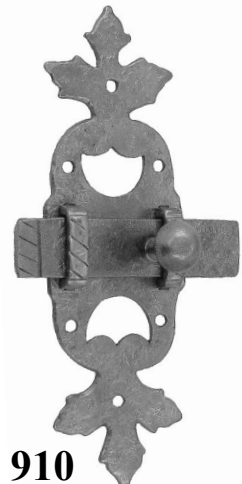

910

GONDS - LAMES - QUEUES DE RAT - FICHES À LARDER

Pour porte chantournées (PETIT MODEL)

Disponibles naturel ou noir oxydé

10- 1

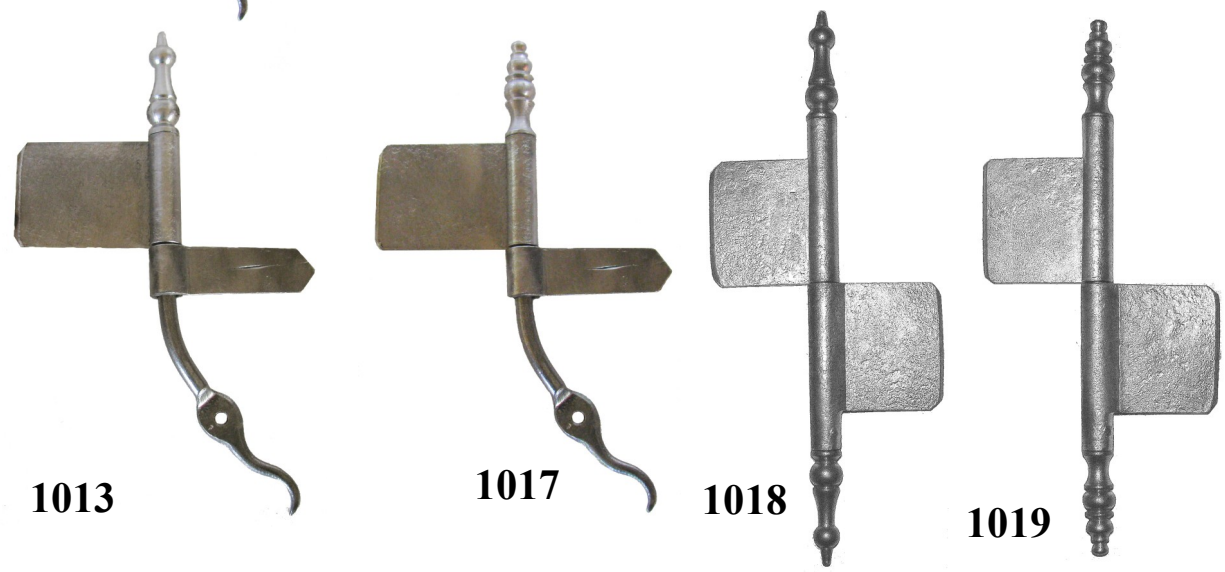
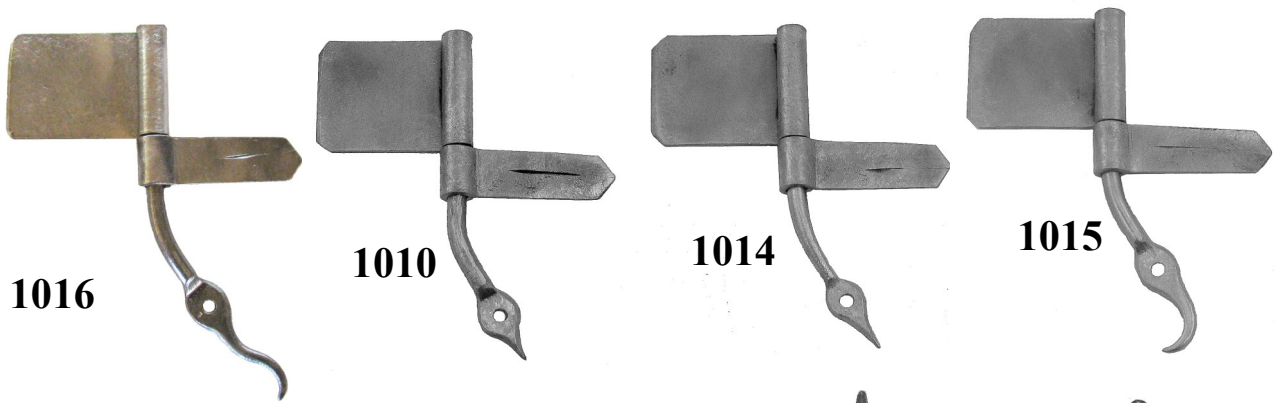
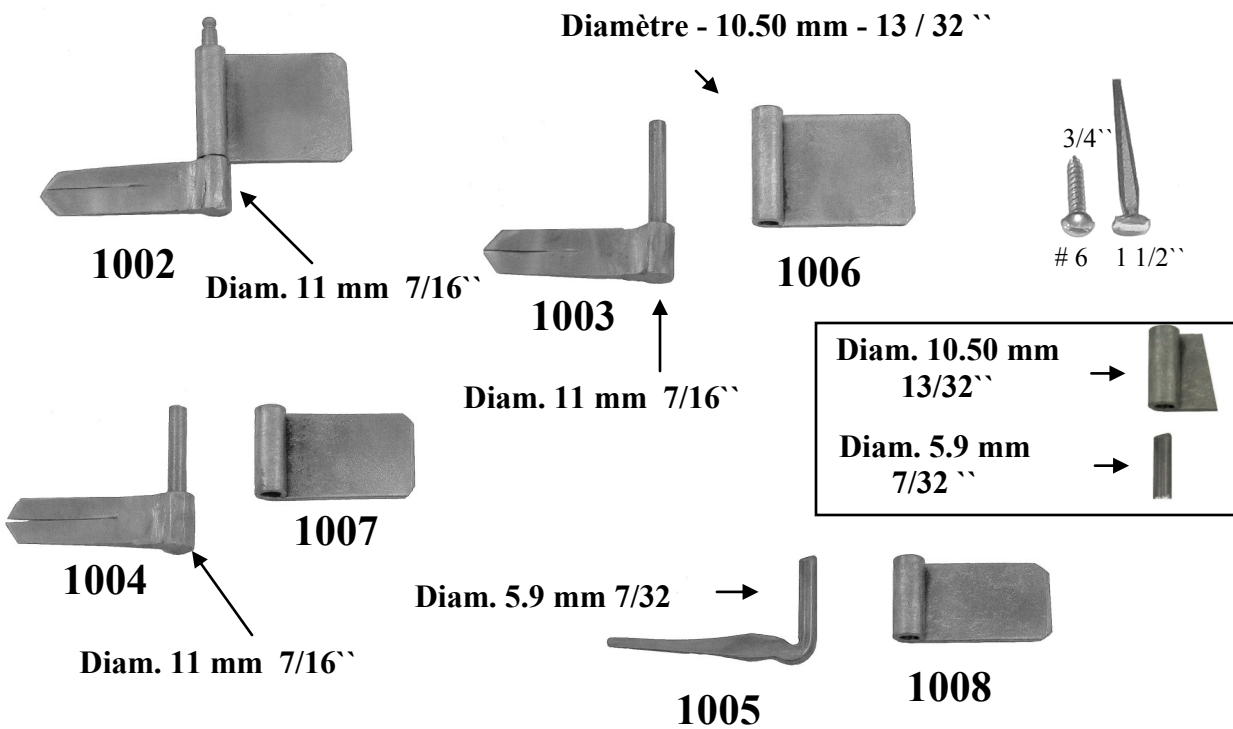

11-1

GONDS - LAMES - QUEUES DE RAT - FICHES À LARDER
Pour porte chantournées (GROS MODEL)
Disponibles naturel ou noir oxydé

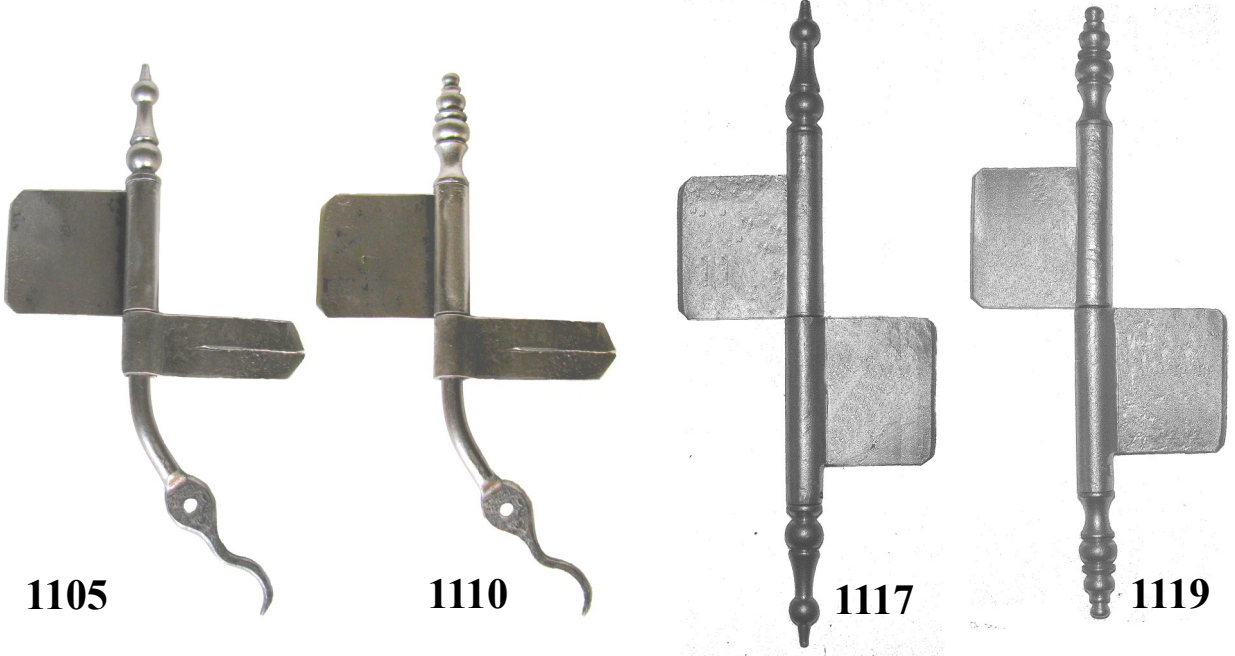
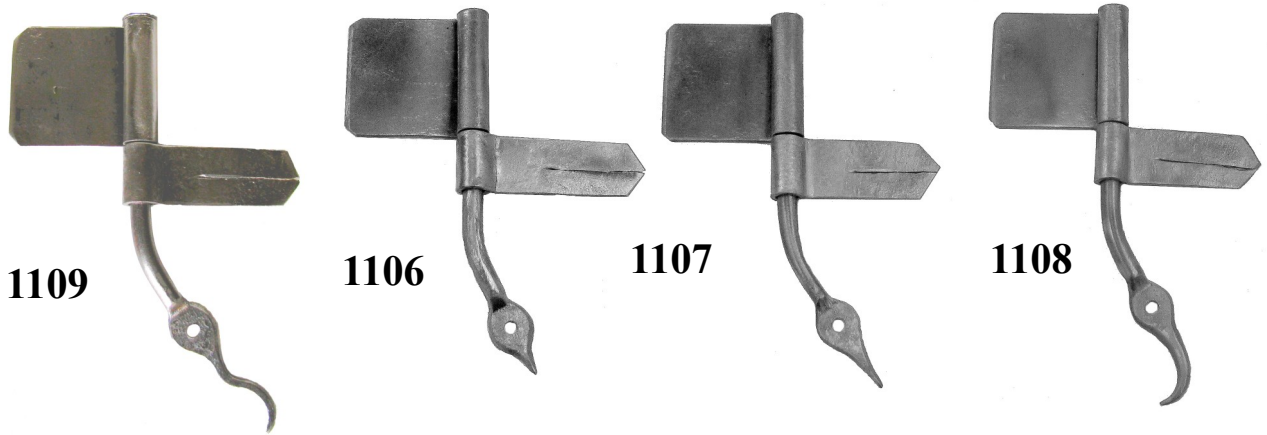
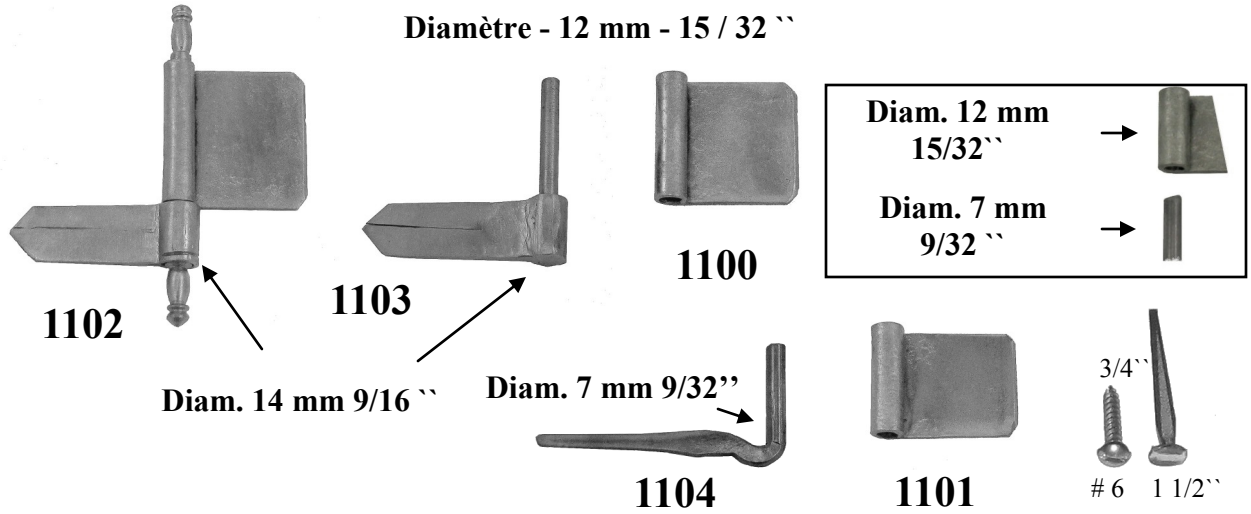

PAUMELLES POUR PORTES (Pour porte entrée à vif)

Disponibles naturel ou noir oxydé

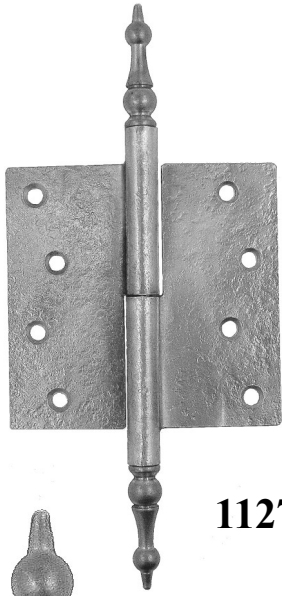

1127



1136



1138

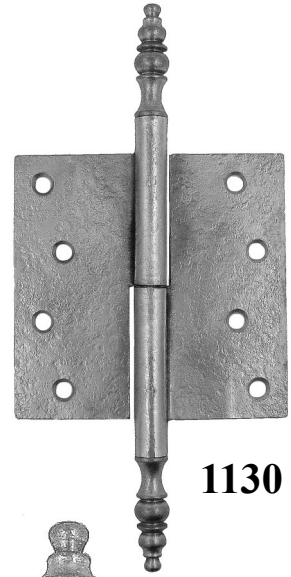

1130

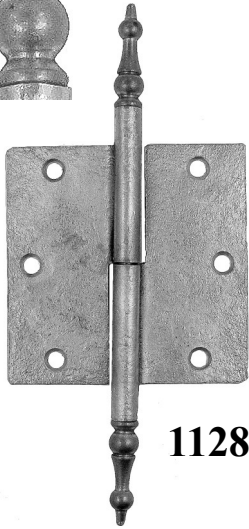

1128



1137



1139



1131

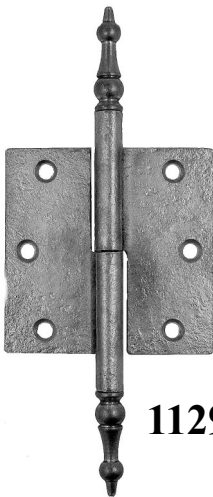

1129

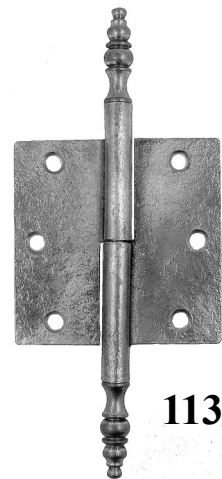

1132

CHARNIÈRES ÉPAISSEUR DE 2.38MM 3/32"

GONDS & GONDS DE SURFACE

Disponibles naturel ou noir oxydé

12- 1 13-1

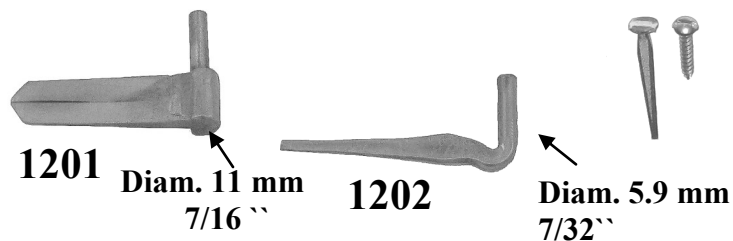

Pour porte entrée a vif



1208



1209



1210



1211



1212

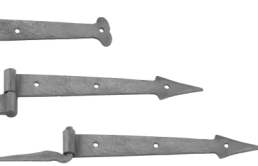
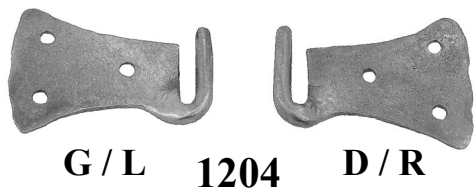
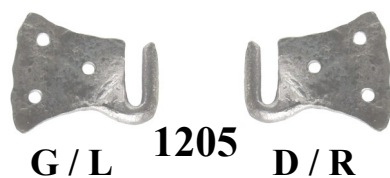

1207

13-1

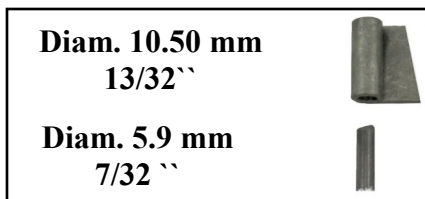

1308



1309

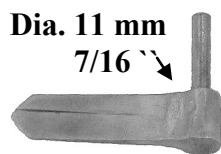

1301



1302



1310



1311

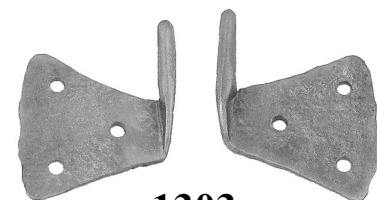

G/L

1304

D/R

1307



1312



CHARNIÈRES ÉPAISSEUR DE 3MM 1/8"

GONDS & GONDS DE SURFACE

13- 2

Disponibles naturel ou noir oxydé

Pour porte entrée à vif

Diam. 14mm 9/16"	
Diam. 8 mm 5/16"	

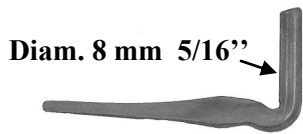

1328



1329

Diam. 16 mm 5/8"

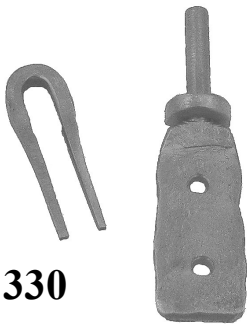

1330

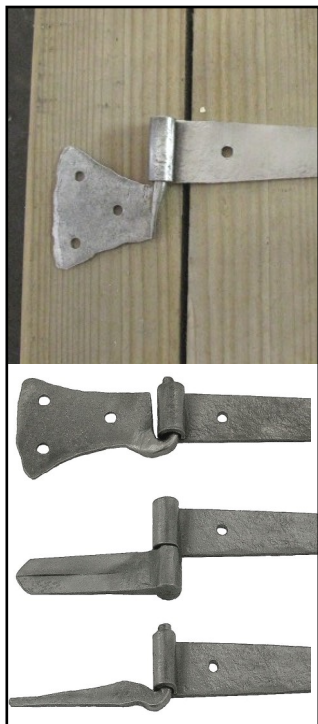

G / L

1316

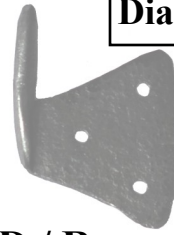

D / R



1318



G / L

1317



D / R



1319



1320



1321



1322



1323



1324



1325



1326

GONDS DE SURFACE AVEC CHARNIÈRES PAUMELLES & QUEUES DE RAT DE SURFACE

14- 1

Disponibles naturel ou noir oxydé

Pour porte entrée à vif

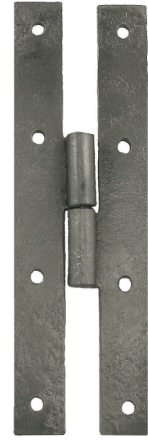
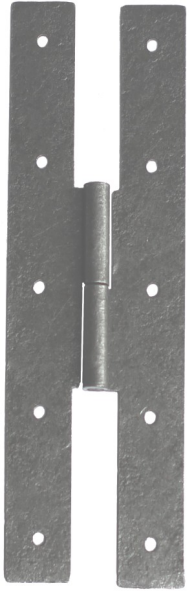
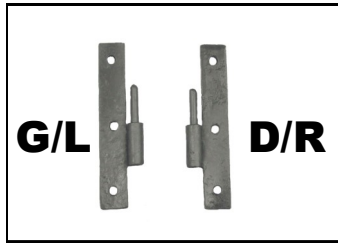

1413

1401

1402

1403

1410

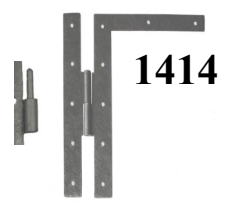
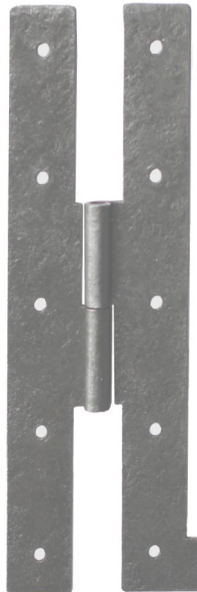

G/L

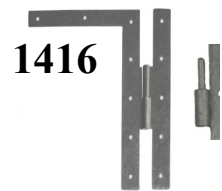

D/R

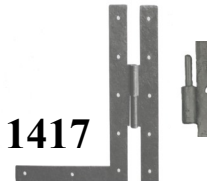
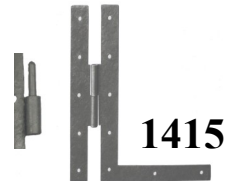

1404



1405



1411

CHARNIÈRES À PLAT & ÉQUERRES DÉCORATIFS

Disponibles naturel ou noir oxydé

15- 1

Pour porte entrée à vif



1501



1514

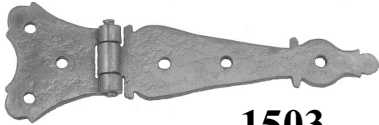

1503



1505



1515



1510

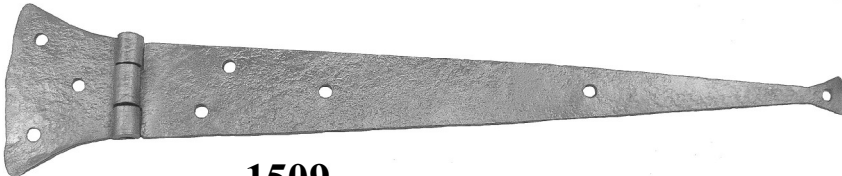

1509



1507

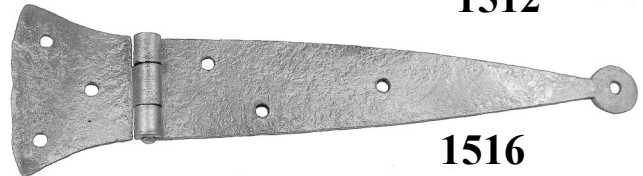

1516



1508



1513



1502

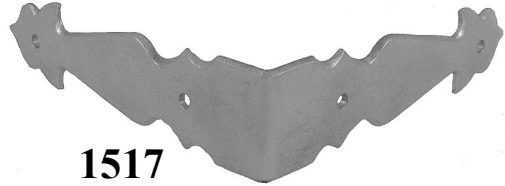

1517



1504

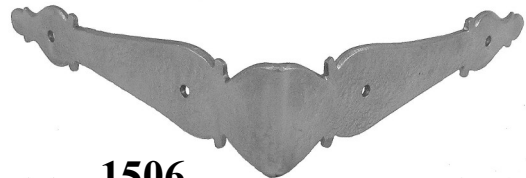

1506



1511



1512



10

8

CHARNIÈRES DE COFFRES - POIGNÉES

SERRURES DE COFFRES

Disponibles naturel ou noir oxydé

16- 1

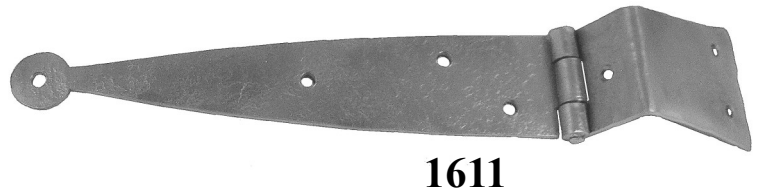
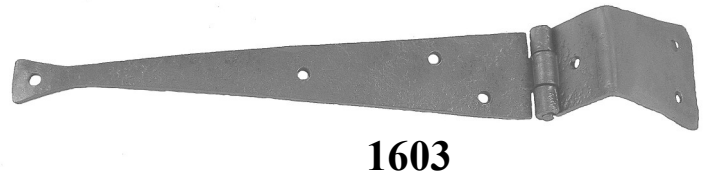
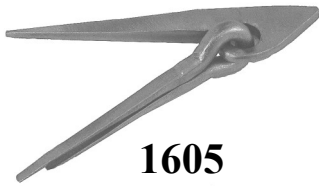
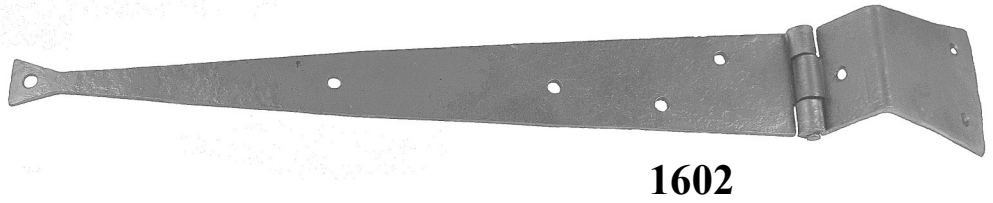
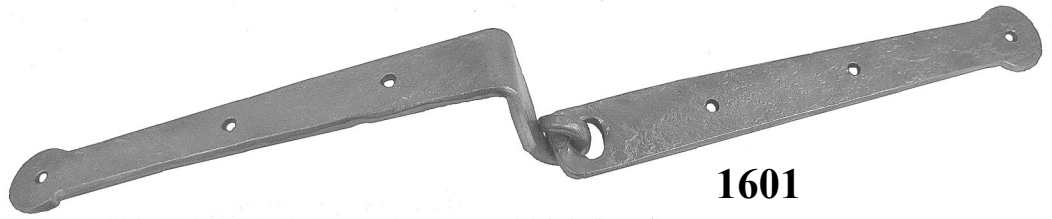
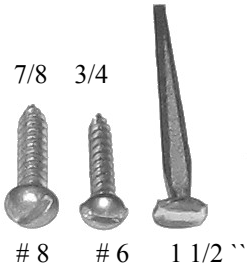

1606

25 mm X 202mm
1" X 8"

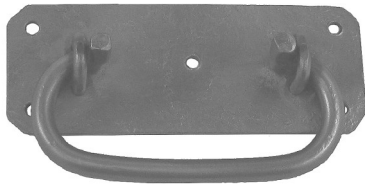
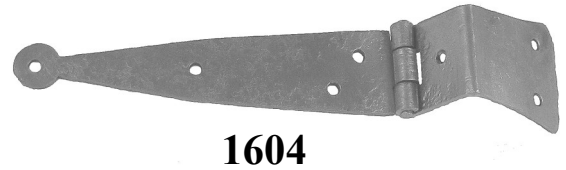

25 mm X 175mm
1" X 7"

1607

Cle Include



Cle Include



Cle Include



1609

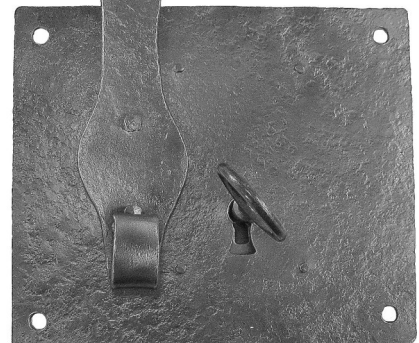

1610

CHARNIÈRES ÉPAISSEUR DE 4.8MM 3/16"

GONDS & GONS DE SURFACE

Disponibles naturel, noir oxydé ou peints

NEW

17-01

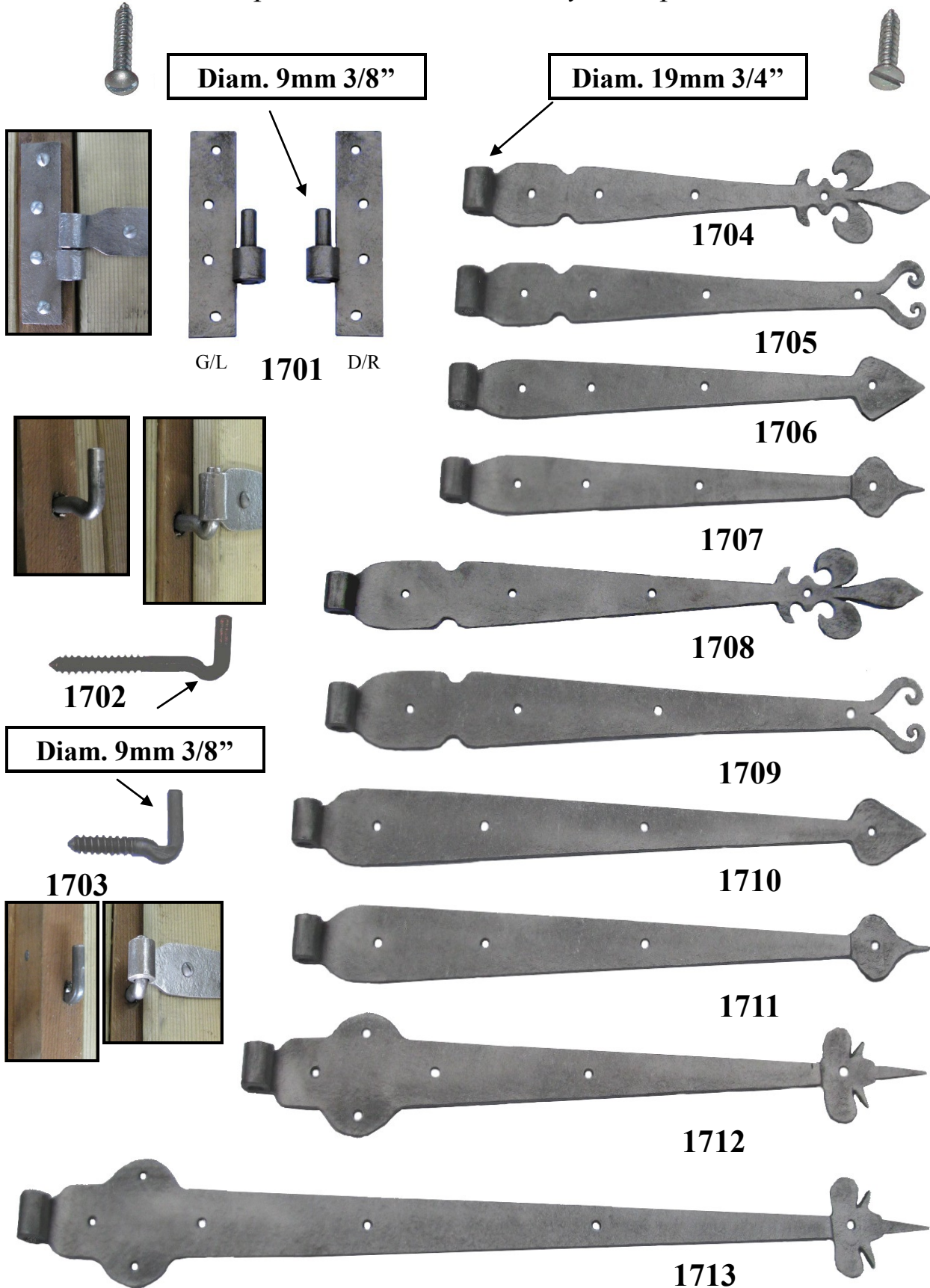

19- 1

POIGNÉES A TIRER - FERME VOLET
Disponibles naturel, noir oxydé ou peinturées

